

Calendar „Pentagon“

The model was originally designed by Tomoko Fuse, Japan and designed as a calendar by Sara Giarrusso and Ramin Razani, Italy. Pictures and the diagrams (Paola Scaburri) are published at

<http://www.origami-cdo.it/modelli/pdf/>



Centro Diffusione Origami

This calendar-model was optimised by Matthias Eichel, Kassel and Stefan Delecat, Göttingen, provided with optimised folding instructions too and published as calendar in German and English language first for 2007 and now **for 2018** for the members and all friends of Origami Deutschland.

Happy folding

Stefan Delecat and Matthias Eichel



January



June

MARCH

Su	M	Tu	W	Th	F	Sa
7	1	2	3	4	5	6
14	8	9	10	11	12	13
21	15	16	17	18	19	20
28	22	23	24	25	26	27
	29	30	31			

2021

insert into
February
unit



June

February



October

JANUARY

Su	M	Tu	W	Th	F	Sa
				1	2	3
4	5	6	7	8	9	10
11	12	13	14	15	16	17
18	19	20	21	22	23	24
25	26	27	28			



insert into
March
unit



Oktober

March



May

FEBRUARY

Su	M	Tu	W	Th	F	Sa
				1	2	3
4	5	6	7	8	9	10
11	12	13	14	15	16	17
18	19	20	21	22	23	24
25	26	27	28	29	30	31

2021

insert into
January
unit



May

April



March

JUNE

Su	M	Tu	W	Th	F	Sa
1	2	3	4	5	6	7
8	9	10	11	12	13	14
15	16	17	18	19	20	21
22	23	24	25	26	27	28
29	30					

2021

insert into
August
unit



March

May



April

JULY

Su	M	Tu	W	Th	F	Sa
6	7	8	9	10	11	12
13	14	15	16	17	18	19
20	21	22	23	24	25	26
27	28	29	30	31		

2021

insert into
December
unit



April

June



November

AUGUST

Su	M	Tu	W	Th	F	Sa
					1	2
3	4	5	6	7	8	9
10	11	12	13	14	15	16
17	18	19	20	21	22	23
24	25	26	27	28	29	30



insert into
April
unit



November



July



September

DECEMBER

Su	M	Tu	W	Th	F	Sa
1	2	3	4	5	6	7
8	9	10	11	12	13	14
15	16	17	18	19	20	21
22	23	24	25	26	27	28
29	30	31				



insert into
May
unit



September

August



July

APRIL

Su	M	Tu	W	Th	F	Sa
						1
						2
						3
						4
						5
						6
						7
						8
						9
						10
						11
						12
						13
						14
						15
						16
						17
						18
						19
						20
						21
						22
						23
						24
						25
						26
						27
						28
						29
						30
						31

100%

insert into
June
unit



July

September



August

NOVEMBER

Su	M	Tu	W	Th	F	Sa
						1
2	3	4	5	6	7	8
9	10	11	12	13	14	15
16	17	18	19	20	21	22
23	24	25	26	27	28	29
30						

insert into
October
unit



August

October



December

SEPTEMBER

Su	M	Tu	W	Th	F	Sa
7	1	2	3	4	5	6
14	8	9	10	11	12	13
21	15	16	17	18	19	20
28	22	23	24	25	26	27
	29	30	31			

2021

insert into
November
unit

December

November



January

OCTOBER

Su	M	Tu	W	Th	F	Sa
				1	2	3
4	5	6	7	8	9	10
11	12	13	14	15	16	17
18	19	20	21	22	23	24
25	26	27	28	29	30	

2021

insert into
September
unit



January

December



February

MAY

Su	M	Tu	W	Th	F	Sa
	2	3	4	5	6	7
9	10	11	12	13	14	15
16	17	18	19	20	21	22
23	24	25	26	27	28	29
30	31					

2021

insert into
July
unit

February

Folding Diagram page 1

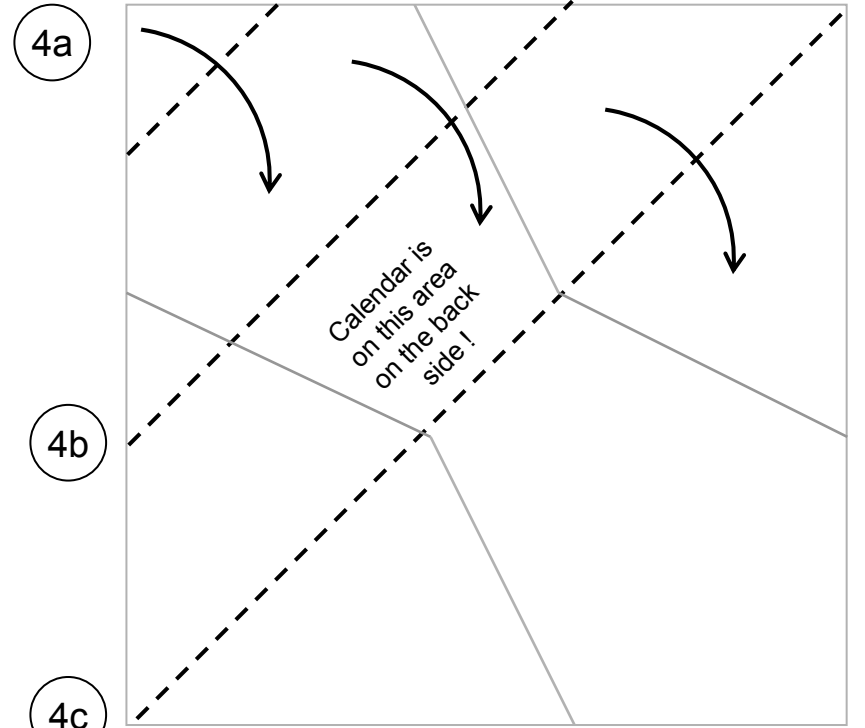
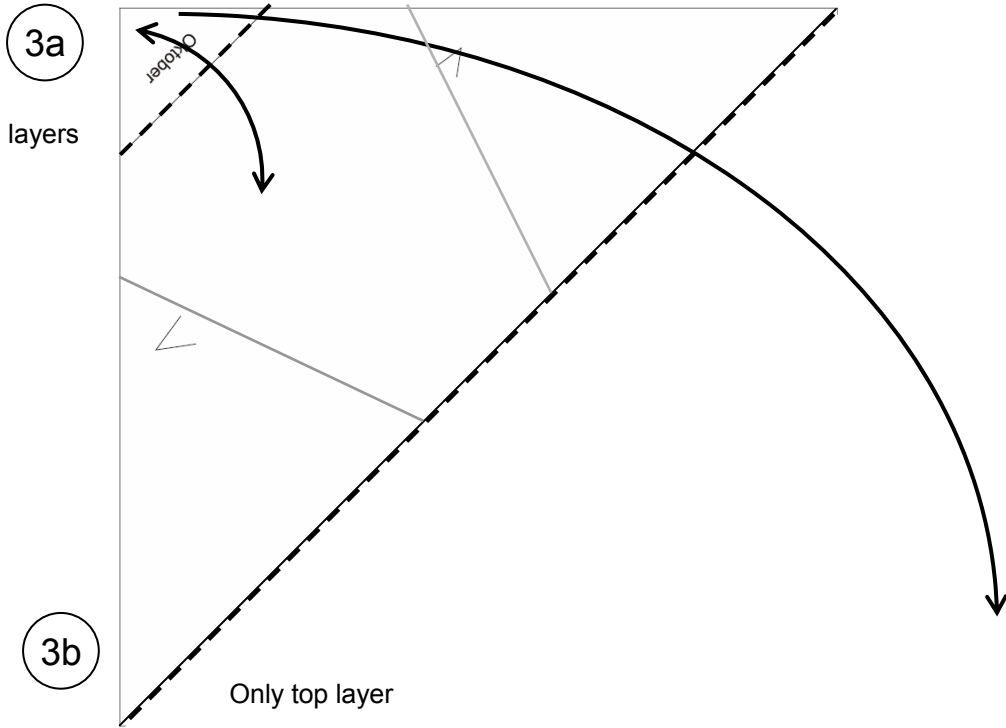
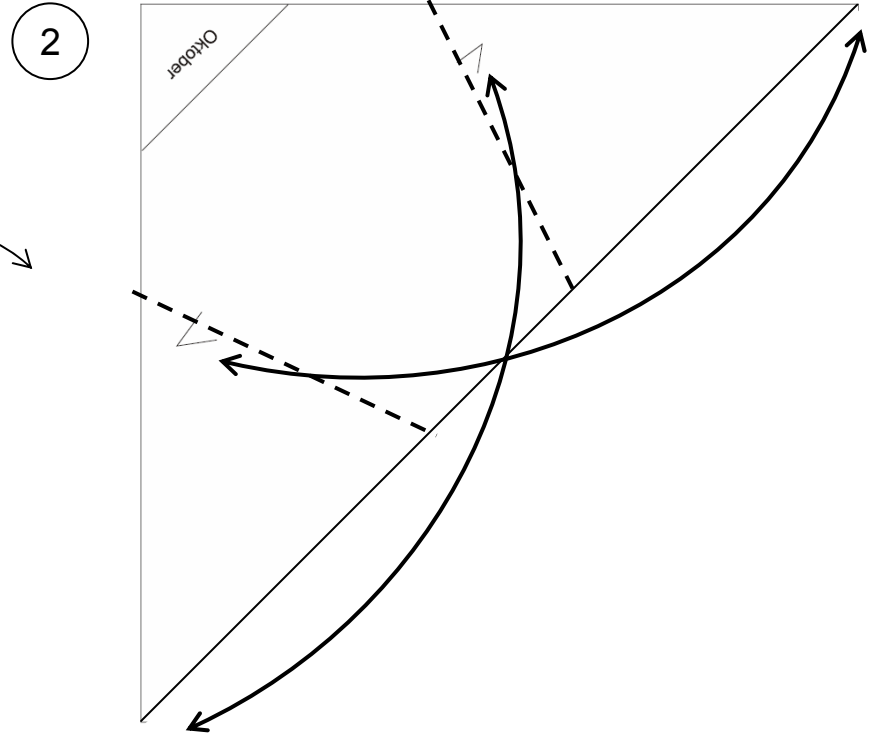
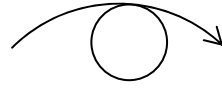
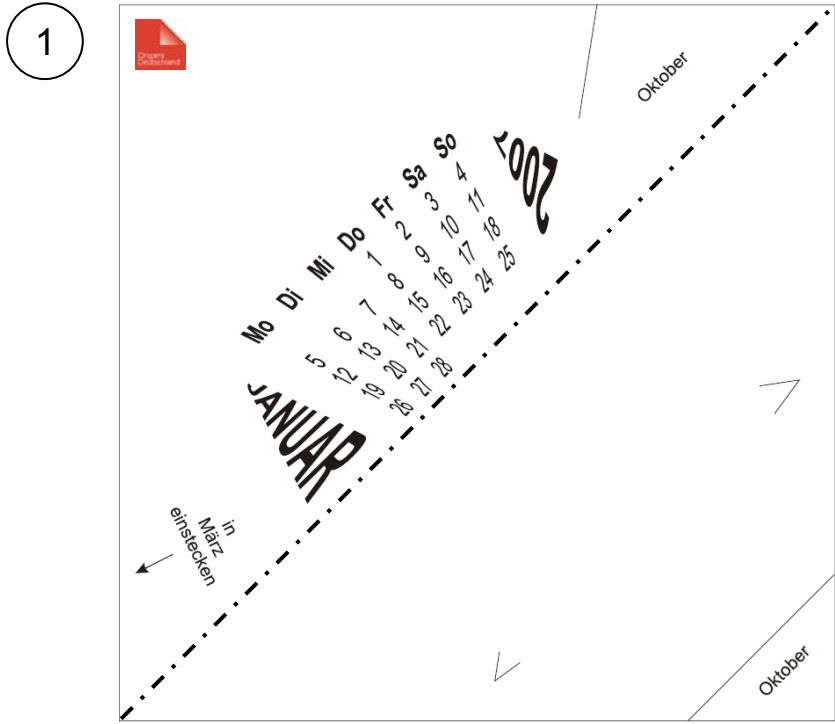

5

Mountain fold only bottom layer

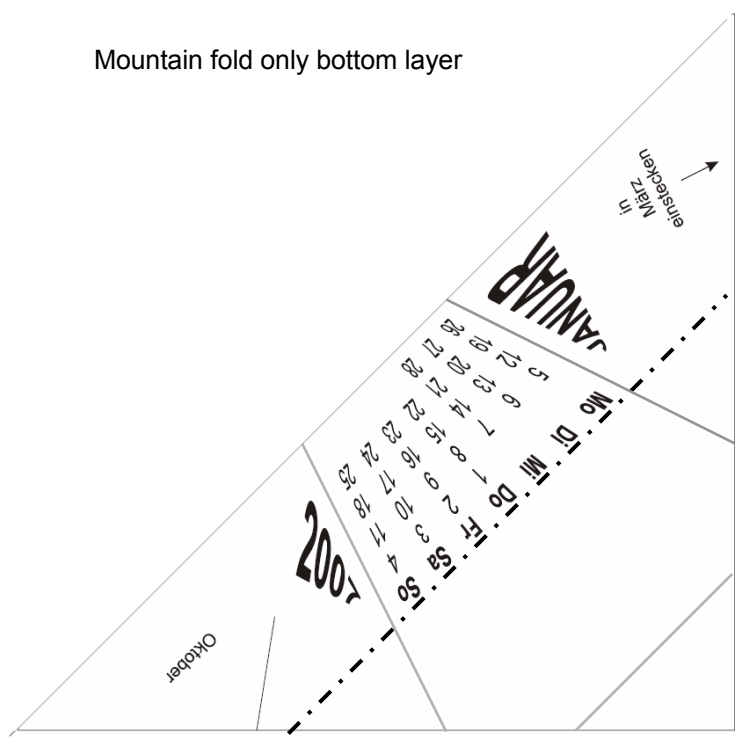

6

Mountain fold the existing crease through all layers

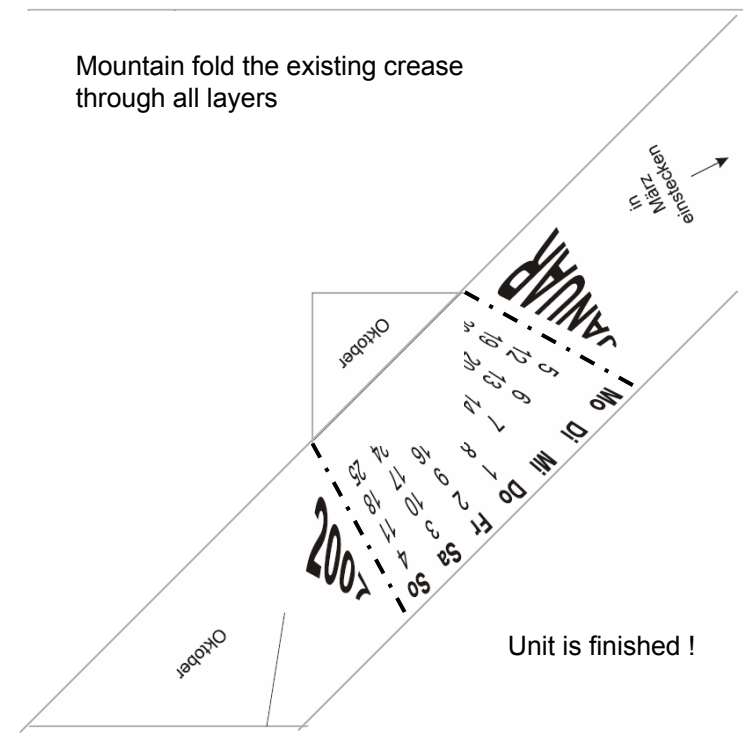

Folding Diagram page 2

- 7a Put the flap of unit 2 into the pocket of unit 1
Note: The month written on the flap of unit 2 refers to the unit with the imprinted name of this month with expanded font (unit 1)
- 7b Put the outer edge of unit 2 to the marking line of unit 1. Fold the supernatant little flaps over and put them into the pockets.
- 7c Put the outer edge of unit 1 to the marking line of unit 2. Fold the supernatant little flaps over and put them into the pockets.

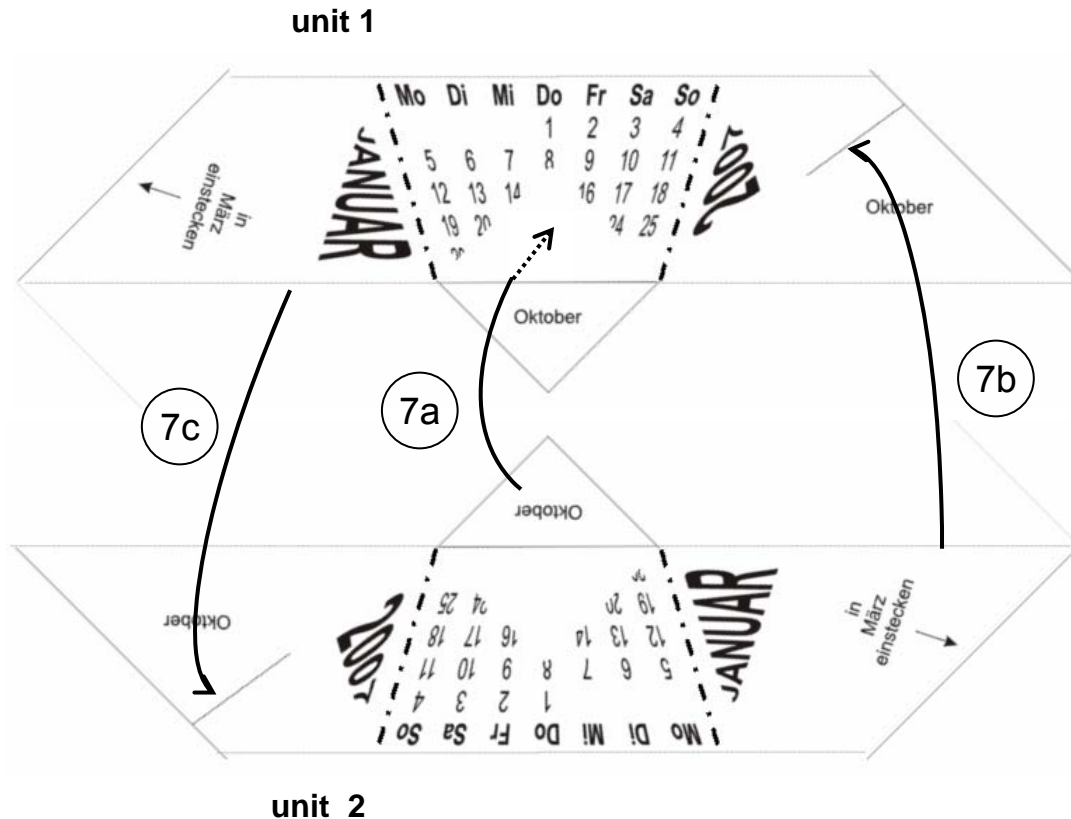

Assembly

- 8 Make 6 of these „duo-units“
- 9 Put the „duo-units“ together to finish the Pentagon
Note: The advice „put into pocket of month“ means, that the flap of the unit with this advice is put into the pocket of the unit with imprinted name of the month with expanded font

Suggestion for multi-coloured calendars

Paper with imprinted name of the month ...	Coloured calendar with 1 colour	Coloured calendar with 3 colours	Coloured calendar with 6 colours	Coloured calendar with 12 colours
March	Colour 1	Colour 1	Colour 1	Colour 1
June	Colour 1	Colour 1	Colour 6	Colour 2
September	Colour 1	Colour 1	Colour 6	Colour 3
December	Colour 1	Colour 1	Colour 1	Colour 4
November	Colour 1	Colour 2	Colour 2	Colour 5
August	Colour 1	Colour 2	Colour 5	Colour 6
May	Colour 1	Colour 2	Colour 5	Colour 7
February	Colour 1	Colour 2	Colour 2	Colour 8
October	Colour 1	Colour 3	Colour 3	Colour 9
January	Colour 1	Colour 3	Colour 4	Colour 10
April	Colour 1	Colour 3	Colour 4	Colour 11
July	Colour 1	Colour 3	Colour 3	Colour 12

Folding Diagram for a calendar holder „column“ (a variation of the „chopstick holder “ by Didier Boursin)

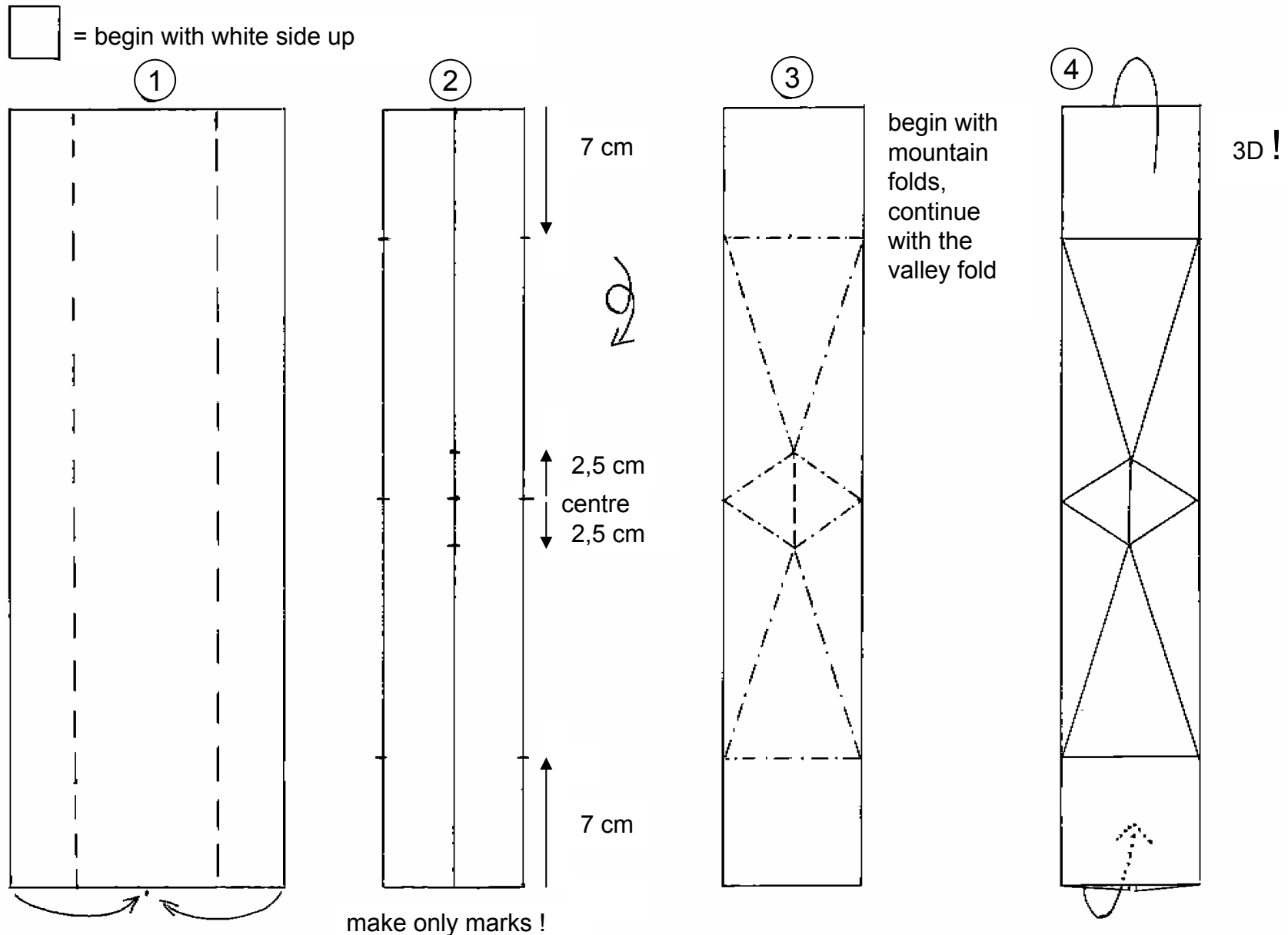

Suggestion for paper format: $\frac{1}{2}$ of DIN A 3 = 42 cm x 14,8 cm, best result with 160g-paper,
Suggestion for colour: black paper (coloured on both sides)

Background- Information: geometrical basis

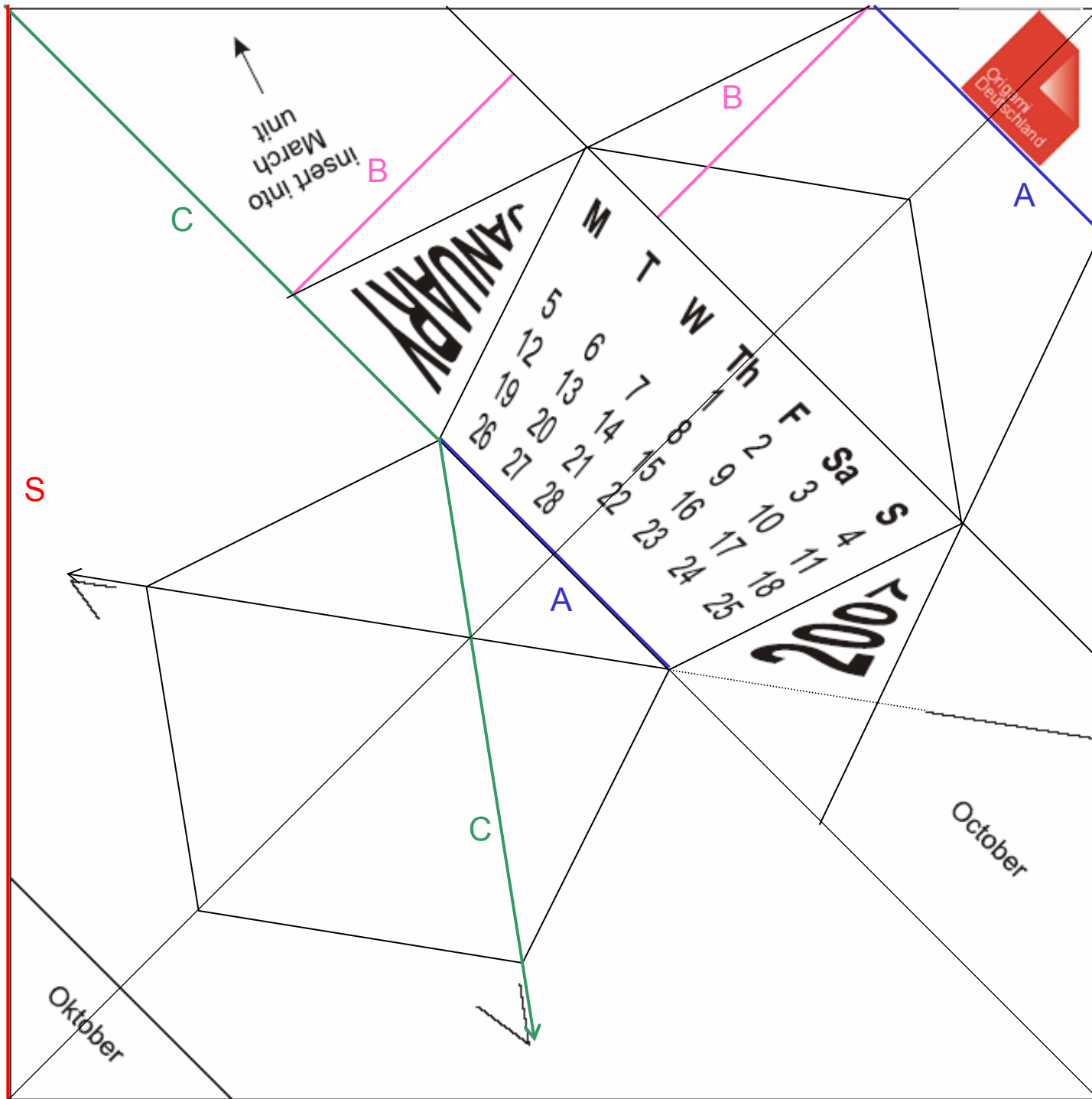

For a given regular pentagon with side length „A“ the size of the square is the following:

The "height" of the Pentagon from the bottom line up to the broadest place „B“ (1st parallel line to the diagonal line of the square) is duplicated (2nd parallel line to the diagonal line).

The length of this diagonal line is „A“. On top we put another right-angled triangle. This entire construction make up 1/2 of the length of the diagonal line of the final square.

The side length „S“ of the final square results as:

$$S = 2 \times \sqrt{\frac{(2B + 0,5A)^2}{2}}$$

The position of the arrows is:

You take an arrow with length: From an edge of the square to the beginning of the bottom edge of the pentagon „C“ and twist it that it starts at the bottom edge of the pentagon and points through the meeting point of the 1st parallel line with the pentagon. The end of the arrow is the "magic" point we looked for.